

SLi3Pro Inverted Fluorescence Microscope



Version 2.0

INTRODUCTION

LAXCO has been a leading provider of high precision, cutting edge optical instruments and microscopes for over 30 years. Our products span a complete range of applications including education, clinical, life science research, and industrial. Our commitment to engineering excellence, breakthrough innovations, and cost effective solutions, makes us one of the most reliable suppliers in the industry. Our products come with a heritage of technical strength, manufacturing discipline, and a prominent reputation of advanced engineering. We currently hold over 15 patents for lighting, design, and technology and our designs incorporate numerous innovative features, address issues others may overlook, and come with a strong industry-proven reputation. Product development is based in Washington State with electrical, mechanical, and optical engineers on site.

Introducing the new enhanced SLI3PRO inverted microscope designed as a high quality fluorescence microscope, ideal for every research need from the very basic to the high performance applications. Laxco has improved on the original design of the LMI3000 by introducing a completely redesigned fluorescence light path. The original SLI6, with its innovative design took a Giant Leap Forward in Fluorescence Microscopy and now, the SLI3PROs enhance SeBaLIT™ design is changing the path to seeing Florescence.

KEY FEATURES

INFINITY OPTICAL SYSTEM

Spherical and chromatic corrected infinity optical system providing excellent optical quality in any application.

LARGER FIELD OF VIEW

The Field of View has been increased to 22mm through the eyepieces.

ERGONOMIC DESIGN

Compact stand design with focus controls placed low on the microscope stand to provide optimal ergonomics.

LIGHT CUBE AND EXCITATION LED IDENTIFICATION

Light cubes and excitation LED are identified allowing identification by the SeBaLIT™ software.

LED ILLUMINATION

Long life LED illumination in both transmitted and fluorescence modes.

PHASE CONTRAST ILLUMINATION

Phase contrast illumination system provides excellent contrast for viewing of live cell/tissue culture samples.

MULTI-ILLUMINATION CONTRAST (MIC)

A new approach to microscopy that combines multiple contrast methods into a simple easy-to-use system that's almost entirely digital.

SINGLE & MULTI-ILLUMINATION MODE

Two modes of operation for more versatility.

ATTACHABLE MECHANICAL STAGE

The optional mechanical stage provides precise sample control at higher magnifications and is user installable with no tools required.

ERGONOMIC DESIGN

Compact stand design with focus controls placed low on the microscope stand to provide optimal ergonomics.

EMISSION FILTERS

One multi-wavelength and three single wavelengths.

ENHANCED DARKFIELD CONTRAST

Provides a simple means to locate your focal plane while remaining in fluorescence mode.

SEBALIT™ EPI-FLUORESCENCE ILLUMINATION TECHNOLOGY

New fluorescence illumination technology utilizing a cross-beam splitter creating the same focal plane and equal distance for all channels.

NO DARKROOM REQUIRED

A new approach to microscopy that combines multiple contrast methods into a simple easy-to-use system almost entirely digital.

SEBALIT™ SOFTWARE

Allows control of all illumination through a computer.

APPLICATIONS

Live Cell Culture Analysis
Bacteriology
Microbiology
Neurology and Neuroimaging
Tissue Culture Studies

Drug Discovery
Development Biology
Transgenics
Biotechnology
Diagnostics Fungal Cultures

CONTRAST METHODS

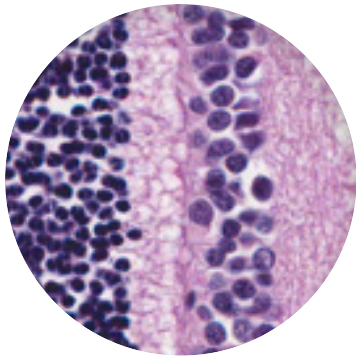

Brightfield

Ideal for stained samples

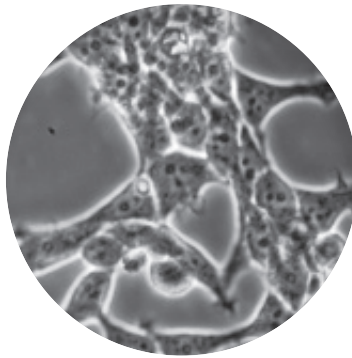

Phase Contrast

View unstained live cells

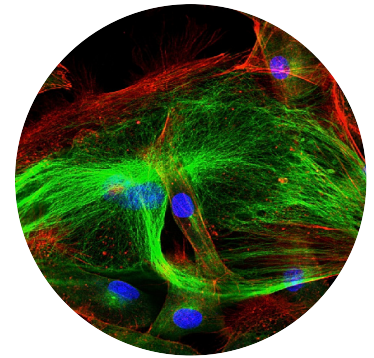

Fluorescence

Up to 3 fluorescent channels

MULTI-ILLUMINATION CONTRAST (MiC)TM

A new approach to microscopy that combines multiple contrast methods into a simple easy-to-use system, controlled digitally through a membrane switch located on the front panel of the microscope; users can turn on any combination of illumination techniques maximizing the specimen details observed.



SEBALIT™ TECHNOLOGY

THE SEBALIT™ TECHNOLOGY

Laxco SeBaLiT™ Technology leaps forward in simplifying a fluorescence microscope by removing a majority of mechanical moving parts, while taking advantage of wavelength specific LEDs coupled with low signal loss. Combined with a multi-band pass filter set, users can achieve rapid switching between channels for real-time viewing of their samples.

Laxco's patent pending approach is the first of its kind that delivers this level of functionality and image quality into a traditional inverted fluorescence microscope. Combined with single bandpass filters, users can produce publication quality photos. The innovated design (patent pending fluorescence module) is located directly below the objective nosepiece reducing the illumination for greater efficiency.

SIMULTANEOUS VIEWING OR IMAGING

Simultaneous viewing or imaging of your specimens removes registration issues that can arise by changing microscope components on traditional fluorescence microscopes.

WAVELENGTH-SPECIFIC LED ILLUMINATION

Adjustable wavelength specific LED intensity to create the perfect ratio between background and signal providing better signal-to-noise ratio, more precise excitation.

LIGHT PATH

Minimal moving parts. All three light paths converge into a single specially engineered and designed prism block located just below the objective turret.

CHANNEL SELECTION

Rapidly switch between excitation light sources by selecting the appropriate LED. Select a single channel or all three.

LIMITED LIGHT LOSS

95% light transmission through SeBaLit's specially designed prism.

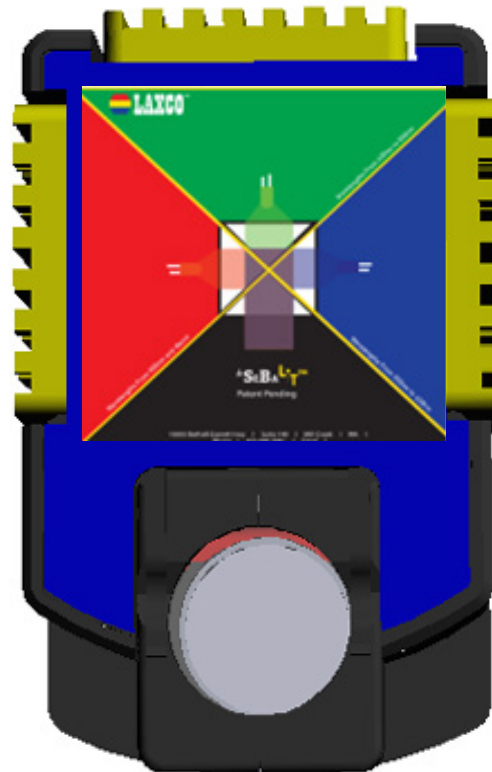
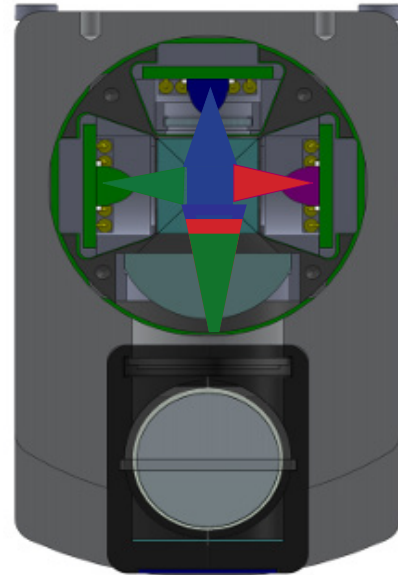

*SEBALIT™

ILLUMINATION

LED FLUORESCENCE

- 50,000-hour life span
- No alignment required
- LED wavelength specific to filter set
- Adjustable light intensity

LED Intensity over 50,000 hours

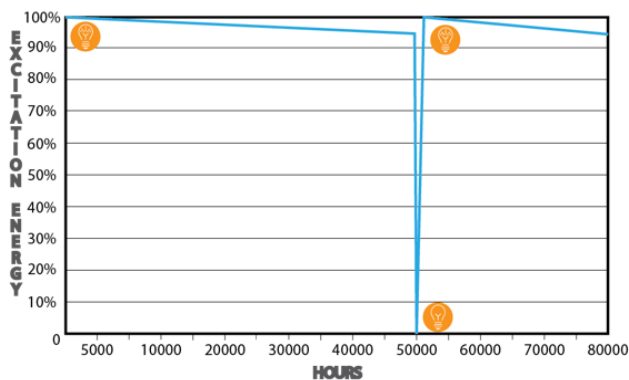

KEY FEATURES

- Blocks out 90% of unwanted light
- Coatings do not break down over time
- Superior signal to noise ratio
- High signal to noise ratio
- Stable light excitation energy
- No warm-up or cool-down time
- Produces no harmful UV light

Mercury Bulb over 250 Hours

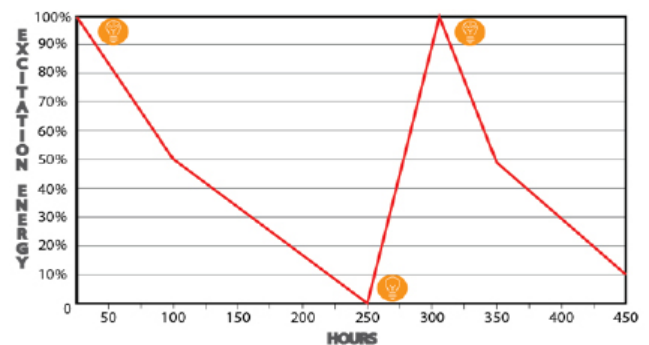

LED's excitation energy degrades less than 5% over a lifetime of 50,000 hours; where mercury drops off 50% in the first 100 hours.

NOTE: With wavelength specific LED, the filters have no unwanted light to block and are ideally suited for imaging at single wavelength.

FILTERS

HARD-COATED FILTERS

Laxco uses hard-coated filters to provide superior performance and durability. Unlike more traditional soft coated filters which only block out 60% of the unwanted light and break down over time, the hard-coated filters block out 90% of the unwanted light, and does not break down over time under any wavelength of light. This greater efficiency produces a superior signal to noise ratio.

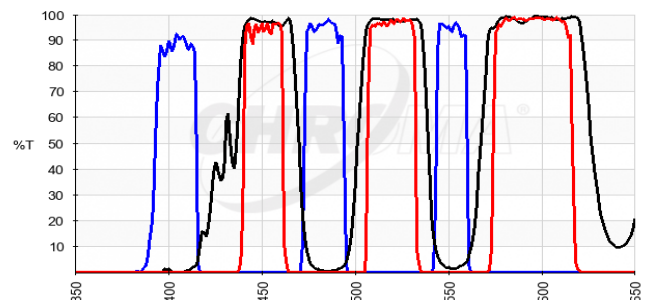

STANDARD SLI3PRO
EMISSION SPECTRUM

NOTE: Best signal to noise ratio and image resolution can be achieved with semi-apo fluorite objectives and wavelength-specific LED.

EPI-FLUORESCENCE

INDIVIDUAL CHANNEL VIEWING

Image or view each channel separately using a wavelength-specific LED with matching EX/EM bandpass filter set.

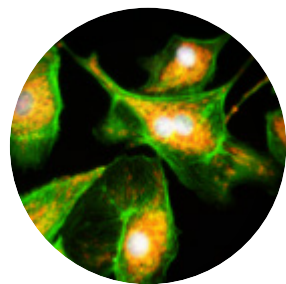
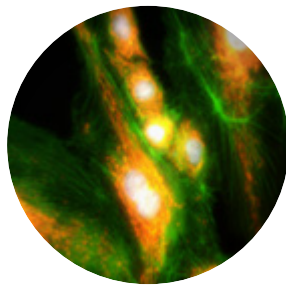
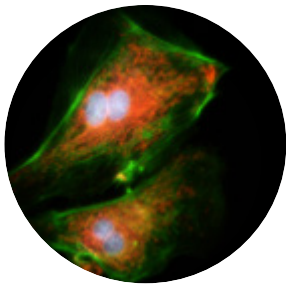
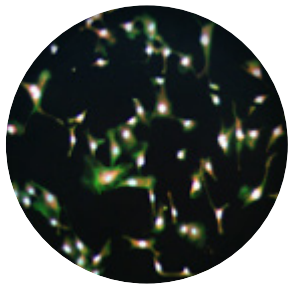

MULTI-CHANNEL VIEWING

No manual overlay or PC software is required to view a multi-channel image. No need to capture each channel individually. All channels can be viewed directly, in real-time on the microscope and/or camera. Using our latest SeBaLiT™ software virtually remove any cross talk across fluorescent channels.

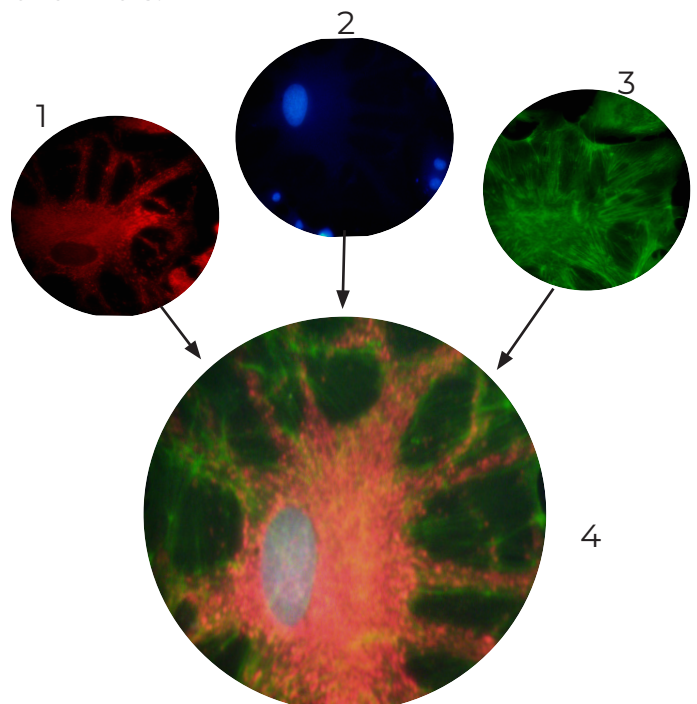

Stained BPEA Cells as seen under 40X Plan Flurite objective through SeBaLiT™ software.

1. RFP 2. DAPI 3. GFP 4. Combined 3 channels

OPERATION

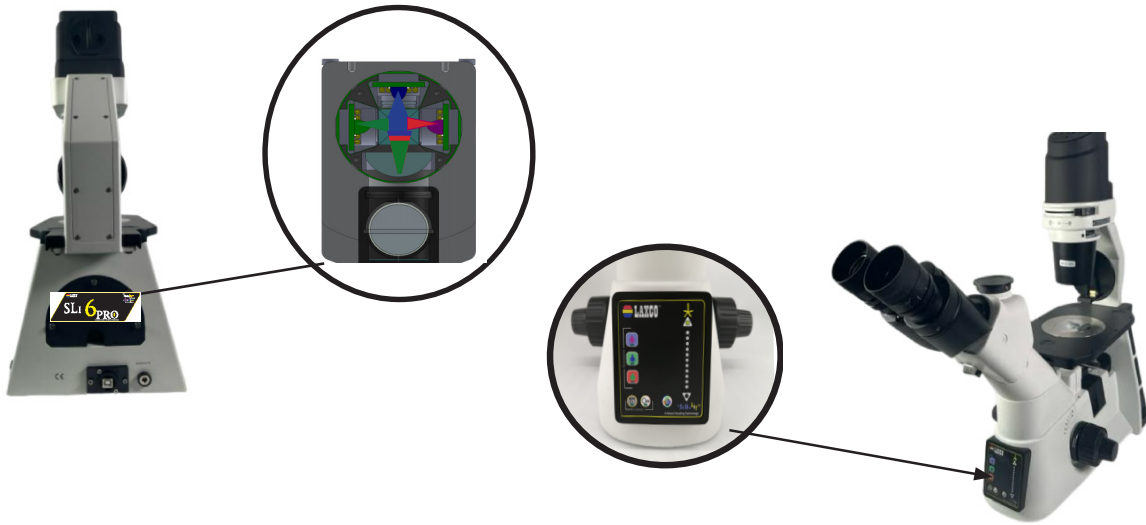

COMBINED MULTI-CONTRAST

Combine fluorescence, phase, and Enhanced Darkfield Contrast.

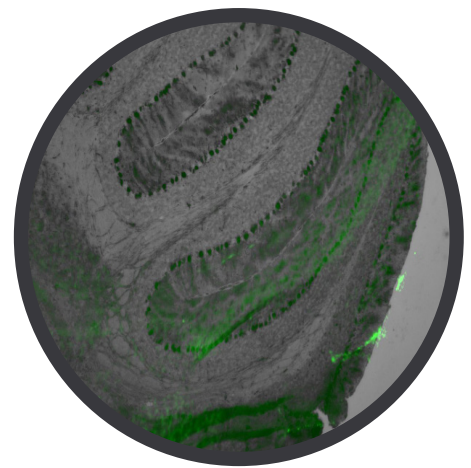
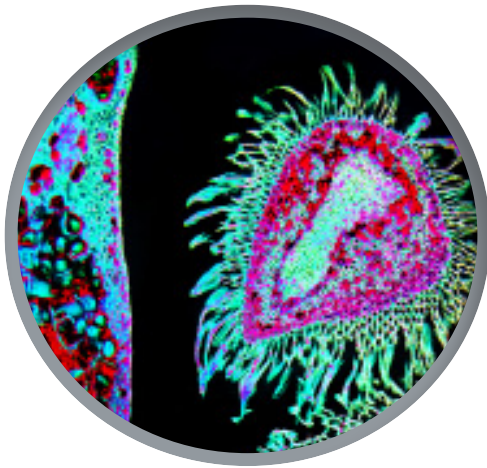

LIGHT SHIELD

No need for a darkroom with Laxco's adjustable light shield.



CONTROLS

FLUORESCENCE CHANNELS

Switch between each fluorescence channel (multi-bandpass filter set requires minimal moving parts).

CONTRAST METHODS

Quickly switch between BF/PH and Enhanced DC.

MULTI-CHANNEL MODE

Quickly switch to multi-channel mode.

BRIGHTNESS CONTROLS

Adjust the brightness for each contrast method or fluorescent channel individually, and the system remembers it.

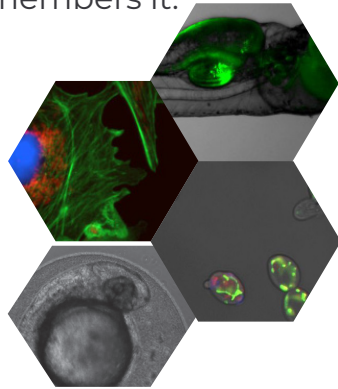

SINGLE CHANNEL MODE

In this mode, users can have the ability to visualize and adjust each individual channel/contrast method brightness level.

MULTI-CHANNEL MODE

One of the key features to the SLi6 Series product line is its multi-channel mode. When selected the user can have the ability to switch on and off any combination of contrast methods. The system utilizes its smart intelligence to recall previously adjusted brightness settings set in single channel mode and recognizes what filter set is in the light path. In this mode users can easily move between channels and capture images quickly.

When combined with a multi-bandpass filter set, users can switch between channels/contrast methods without the need of moving any microscope components.



FLUORESCENCE CHANNELS



CONTRAST METHODS

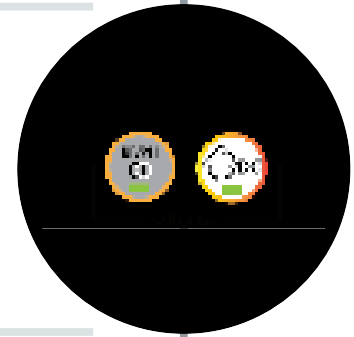

MULTI-CHANNEL MODE

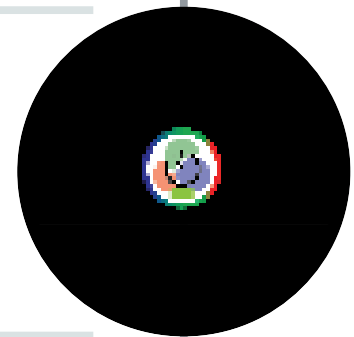

BRIGHTNESS CONTROLS

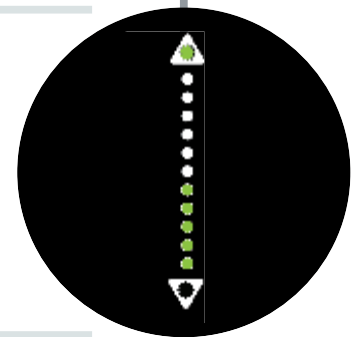

SEBALIT SOFTWARE

SeBaLiT™ Software, in conjunction with its companion controller, changes the way you control your fluorescence microscope by simplifying the complexities associated with the traditional fluorescence microscope. Its seamless integration of camera and microscope creates an easy-to-use fluorescence microscope. SeBaLiT™ Software allow for the user to add annotations and perform measurements on their images, provides complete camera control and capture control, multi-channel observation at the click of a button, and fluorescence imaging settings. The latest version of the software includes a newly developed algorithm that virtually removes any possibility for cross talk.

FLUORESCENCE CONTROL

- Single Channel Viewing
- Multi-viewing Channel Viewing
- Individual Channel Intensity Control
- Contrast Mode Selection
- Capability to recognize fluorescence filters currently installed

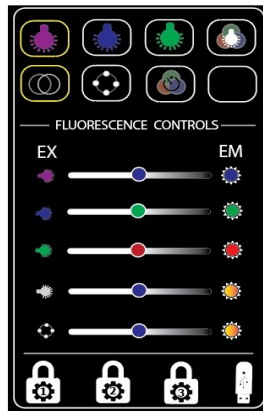

CAMERA CONTROL

- Auto / Manual Exposure Time
- White / Black Balance
- Color Temperature Control
- Brightness / Contrast
- Black & White / Color Mode
- Snap / Video Mode

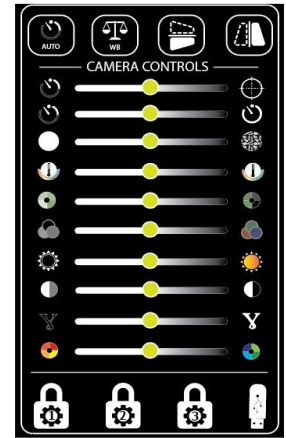

ANNOTATIONS

- Calibration
- Measurements
- Text
- Lines, Squares, and Circles
- Angular Measurements

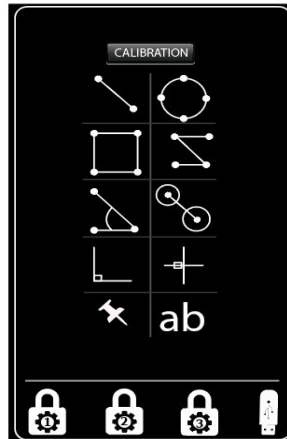

CAPTURE CONTROL

- Save Format
- Time Lapse Control
- File Name Assignment
- Software Information

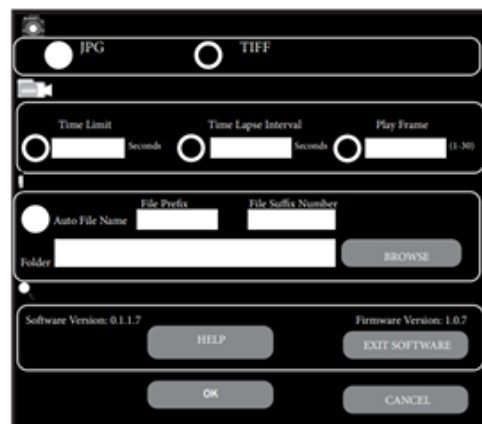

STANDARD CONFIGURATIONS

MODEL	SiI3P-PH1	SiI3P-FL1	SiI3P-FLP
OPTICAL SYSTEM	Infinity corrected	Infinity corrected	Infinity corrected
OBSERVATION TUBE	Fixed Trinocular, 45° inclined head, 360° rotating, Adjustable interpupillary distance 50mm to 75mm, 100:100 image split	Fixed Trinocular, 45° inclined head, 360° rotating, Adjustable interpupillary distance 50mm to 75mm, 100:100 image split	Fixed Trinocular, 45° inclined head, 360° rotating, Adjustable interpupillary distance 50mm to 75mm, 100:100 image split
OBJECTIVES	LWD Infinity 4X plan positive phase contrast objective (10X, 20X)	LWD Infinity fluorescent objective (4X, 10X, 40X)	LWD Infinity plan fluorescent objective (4X 10X) and LWD Infinity plan positive phase contrast objective (20X, 40X)
EYEPIECES	PL10X/22mm 10X eyepiece, adjustable with eyecups	PPL10X/22mm 10X eyepiece, adjustable with eyecups	PL10X/22mm 10X eyepiece, adjustable with eyecups
FIELD OF VIEW	22mm	22mm	22mm
FOCUS	Coarse and Fine - low position coaxial focusing mechanism, coarse range: 25mm, fine precision: 0.002mm, with tension adjustment and upper limit	Coarse and Fine - low position coaxial focusing mechanism, coarse range: 25mm, fine precision: 0.002mm, with tension adjustment and upper limit	Coarse and Fine - low position coaxial focusing mechanism, coarse range: 25mm, fine precision: 0.002mm, with tension adjustment and upper limit
CONDENSER	N.A. 0.3, working distance 72mm, Condenser lens can be removed to view specimens in large vessels	N.A. 0.3, working distance 72mm, Condenser lens can be removed to view specimens in large vessels	N.A. 0.3, working distance 72mm, Condenser lens can be removed to view specimens in large vessels
ILLUMINATION	Variable Intensity Transmitted 5w LED	Variable Transmitted 5w LED Fluorescent Illumination Excitation <ul style="list-style-type: none"> Variable intensity 3W LED; 410nm to 415nm for DAPI excitation Variable intensity 3W LED; 480nm to 485nm for FITC excitation Variable intensity 3W LED; 550nm to 555nm for TRITC excitation Emission Filters <ul style="list-style-type: none"> 455nm ± 25nm for DAPI 525nm ± 18nm for FITC 605nm ± 17.5nm for TRITC Dichroic Filter <ul style="list-style-type: none"> Triple bandpass for DAPI, FITC, TRITC 	Variable Transmitted 5w LED Fluorescent Illumination Excitation <ul style="list-style-type: none"> Variable intensity 3W LED; 410nm to 415nm for DAPI excitation Variable intensity 3W LED; 480nm to 485nm for FITC excitation Variable intensity 3W LED; 550nm to 555nm for TRITC excitation Emission Filters <ul style="list-style-type: none"> 455nm ± 25nm for DAPI 525nm ± 18nm for FITC 605nm ± 17.5nm for TRITC Dichroic Filter <ul style="list-style-type: none"> Triple bandpass for DAPI, FITC, TRITC
STAGE	Fixed stage standard, Mechanical stage with moving range 120(X), 78(Y)mm with metal and glass stage plates, XY coaxial knob place on right side of the plain stage (optional mechanical stage)	Fixed stage standard, Mechanical stage with moving range 120(X), 78(Y)mm with metal and glass stage plates, XY coaxial knob place on right side of the plain stage (optional mechanical stage)	Fixed stage standard, Mechanical stage with moving range 120(X), 78(Y)mm with metal and glass stage plates, XY coaxial knob place on right side of the plain stage (optional mechanical stage)
FILTERS	Transmitted Light Sliders <ul style="list-style-type: none"> Phase Slider (on phase models) pre-centered phase contrast aperture for 4X, 10X, 20X and 40X, and one 45mm empty aperture. 45mm monochromatic contrast color filter (green) Light balancing daylight color temperature transition filter (used primarily in brightfield observations) 	<ul style="list-style-type: none"> 45mm monochromatic contrast color filter (green) Light balancing daylight color temperature transition filter (used primarily in brightfield observations) 	<ul style="list-style-type: none"> 45mm monochromatic contrast color filter (green) Light balancing daylight color temperature transition filter (used primarily in brightfield observations)
NOSEPIECE	Quintuple nosepiece	Quintuple nosepiece	Quintuple nosepiece
CAMERA	SeBaCAM™ Cool 1.7C (Standard)	SeBaCAM™ Cool 1.7C (Standard)	SeBaCAM™ Cool 1.7C (Standard)
SOFTWARE	SeBaLIT™ (patent pending) - OPTIONAL	SeBaLIT™ (patent pending) - OPTIONAL	SeBaLIT™ (patent pending) - OPTIONAL
DIMENSIONS	Depth 23.2 inches (590mm) Width 8.9 inches (226mm) Height 20.0 inches (507mm)	Depth 23.2 inches (590mm) Width 8.9 inches (226mm) Height 20.0 inches (507mm)	Depth 23.2 inches (590mm) Width 8.9 inches (226mm) Height 20.0 inches (507mm)
WEIGHT	26.1 Kilograms	26.1 Kilograms	26.1 Kilograms

ACCESSORIES

UPGRADE KITS	SLI3P-ME-Kit2	Mechanical Stage Upgrade Kit
	SLI3P-DU-Kit3	Digital Camera Upgrade Kit
	SLI3P-FL-Kit1	Kit, Fluorescent Upgrade Kit 1
	SLI3P-FL-Kit4	Kit, Fluorescent Upgrade Kit2
OBJECTIVES / EYEPIECES	1006548	SeBaLit™ Digital Imaging Upgrade Kit
	LMIP-OLIPN4B	LWD infinity plan objective 4X
	LMIP-OLIPN10B	LWD infinity plan objective 10X
	LMIP-OLIPN20B	LWD infinity plan objective 20X
	LMIP-OLIPN40A	LWD infinity plan objective 40X
	LMIP-OLIPN60	LWD infinity plan objective 60X
	LMIP-OLIPP2N4b	LWD infinity plan positive phase contrast objective 4X
	LMIP-OLIPP2N10b	LWD infinity plan positive phase contrast objective 10X
	LMIP-OLIPP2N20b	LWD infinity plan positive phase contrast objective 20X
	LMIP-OLIPP2N40a	LWD infinity plan positive phase contrast objective 40X
	LMIP-OLIPF4	LWD Infinity fluorescent Objective 4X
	LMIP-OLIPF10	LWD Infinity fluorescent Objective 10X
	LMIP-OLIPF20	LWD Infinity fluorescent Objective 20X
	LMIP-OLIPF40	LWD Infinity fluorescent Objective 40X
	LMIP-OLIPF60	LWD Infinity fluorescent Objective 60X
	LMIP-OLIPP2F20	Semi-Apo LWD Infinity plan positive phase contrast objective 20X
	LMIP-OLIPP2F40	Semi-Apo LWD Infinity plan positive phase contrast objective 40X
	LMCP-OIPP100s	Infinity plan achromatic phase contrast objective 100X/1.25
	LMCP-PLN10X22T	High eye point wide field flat field eyepieces PL10X /18mm
	FILTERS	LMIP-IF550
LMIP-LBD		LBD Light Balancing Color Temperature Filter (45mm diameter)
LMIP-ICX40SL		Phase contrast slider
LMCP-LBD		LBD Light Balancing Color Temperature Filter (45mm diameter)
LMCP-XY-FCF		Neutral filter (45mm diameter)
SOFTWARE/ CAMERAS/ C-MOUNTS	1005237	Software SeBaLIT™ Desktop Edition for SLI3P W10 64B
	SeBaCamCool1.4M	1.4MP Mono camera
	SeBaCamCool1.4C	1.4MP color camera
	SeBaCamCool1.7C	Camera, SeBaCamCool1.7C
	LMCP-CX40CTV0.65	0.65XCTV with C mount, focus adjustable
	LMCP-CX40CTV1	1XCTV with C mount, focus adjustable
STAGE	LMIP-ICX41SGM	Mechanical stage with moving range 120(X), 80(Y)mm
	LMIP-XDCPG	Glass Stage Plate
	LMIP-XDCPM3	Metal Stage Insert
	LMIP-XDSGEX	Extension Plate
	LMIP-XDSGHJ02	Slide holder (diameter 54 mm, 26.5X76.5)
	LMIP-XDSGHJ01	35 mm petri dish holder
	LMIP-XDSGHJ03	Terasaki holder (diameter 65 mm, 56X81.5)

* NOTE - Laxco™ is continually striving to improve both the quality and innovative technology used on their microscopes, therefore, specifications and appearances are subject to change without any notice or obligation on the part of the manufacturer. All Laxco microscopes are manufactured in conformance to current antifungal standards. The observation tube is resistant to bacteria and fungi that may be present in the environmental setting of the microscope.

CONFIGURATION CHART

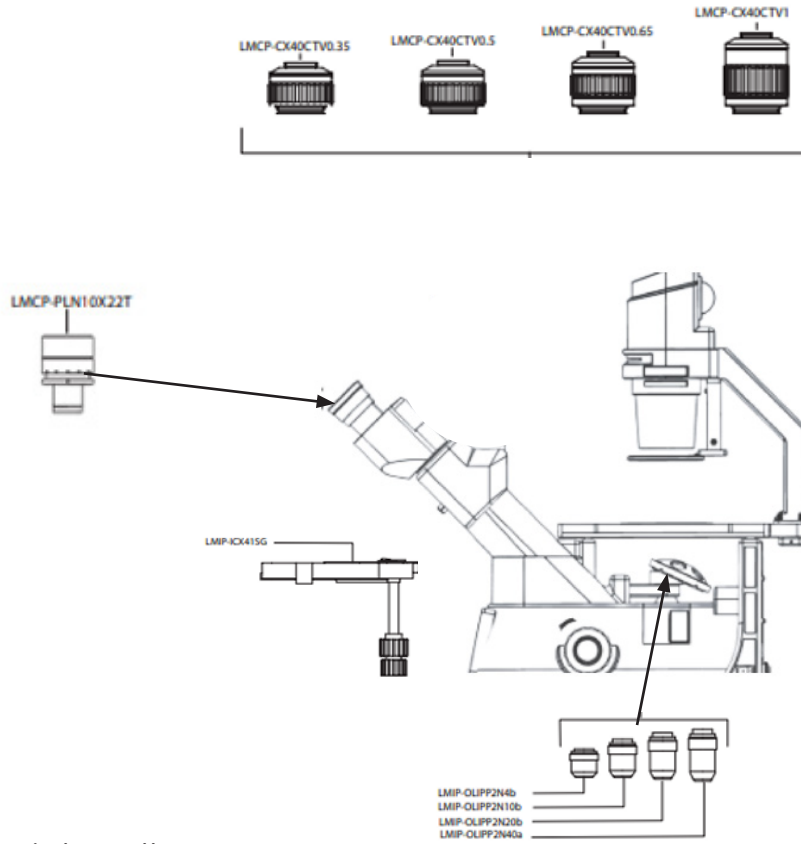

Microscope Weight 55lbs
 Power Requirement is 50Hz and will work in USA and Canada

DIMENSIONS

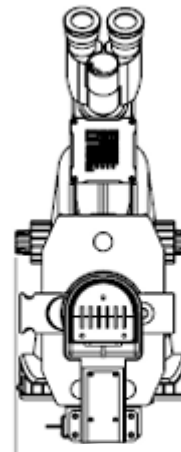
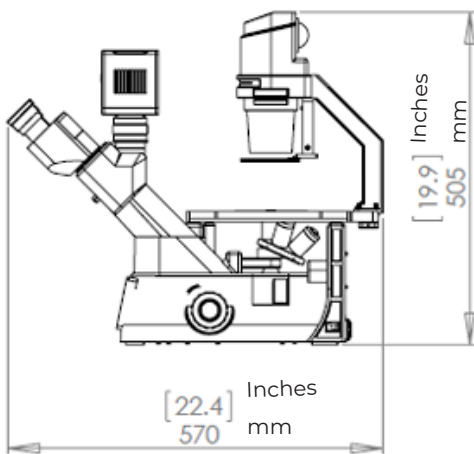

9 Inches
 228 mm



LAXCO, Inc.
18303 Bothell-Everett Hwy
Suite 140
Mill Creek, WA 98012
www.SeBaMicro.com
www.laxcoinc.com

Contact us:
For customer service: 425-686-3081,
option 1
For service support: 425-686-3081, option 2
For technical support: 425-686-3081, option 3

SLI-MKT-DOC-1700105(2)