

Designed to meet the demands of Life Science and Industrial Research

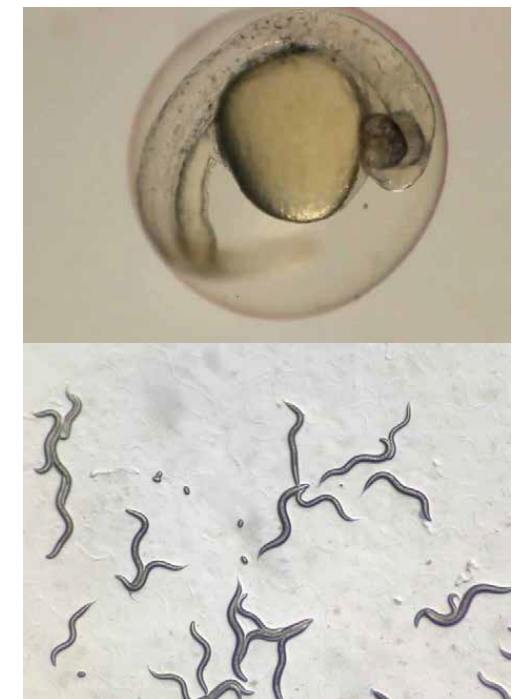

Key Features

- Galilean optical system
- APO objectives
- multiple bases
- multiple illumination and contrast options



Ergonomic Design



High eye-point wide field eyepieces provide a high resolution image. The LMS-Z400 Series comes standard with 10X/23mm eyepieces for a wider field of view and flat image. 15X and 20X eyepieces are available as an option. Adjustable eyepiece diopter for user specific eyesight is standard on all eyepieces.

Coaxial coarse and fine focus mechanism for fast and precise operation. The coaxial mechanism is ergonomic and can be locked for long-term observation.

Tilting viewing head
Features a tilting viewing head from 5 to 45 degrees which can be adjusted to a comfortable height for multiple users.

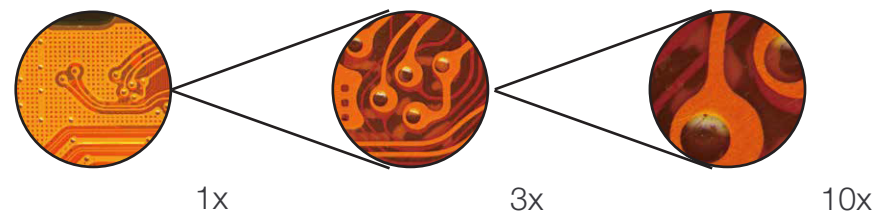

Large zoom ratio 12.5:1
Large zoom ratio from 0.8X to 10X with click stops.

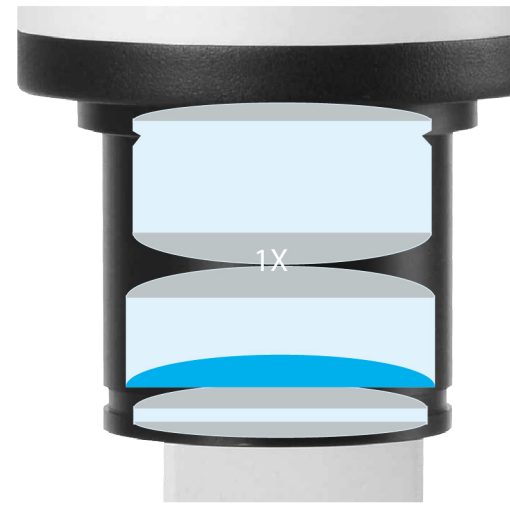

Apochromatic optics

Apochromatic lens design significantly improves lens performance and color rendition. Corrects the axial chromatic aberration of red/green/blue, and converges them to a single focal plane.

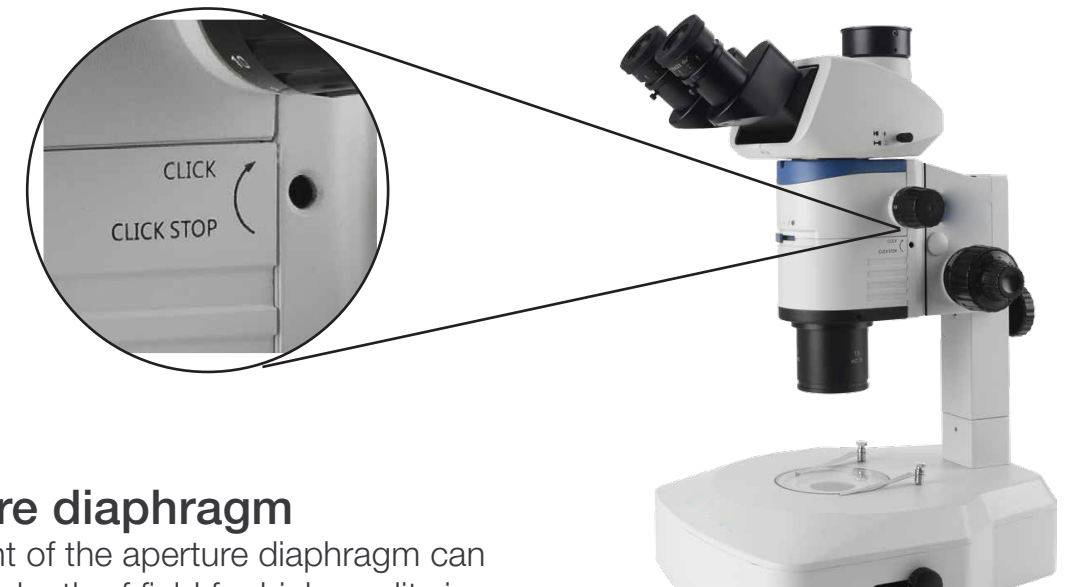
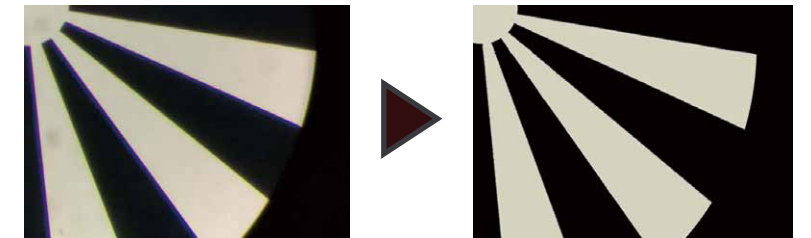

Aperture diaphragm

Adjustment of the aperture diaphragm can adjust the depth of field for high-quality images.

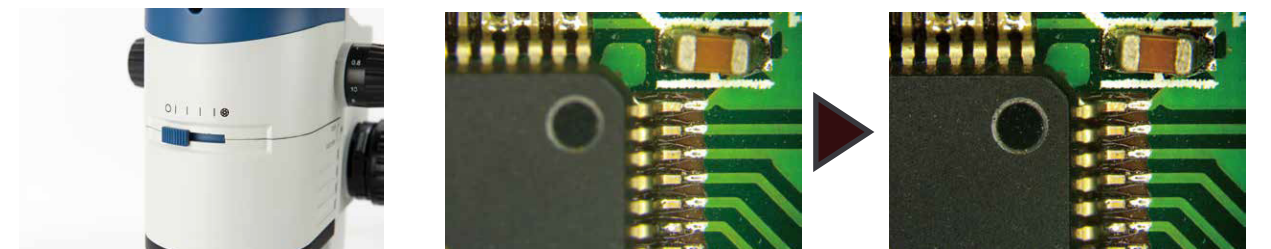

Research Grade Optics



Galilean optical system

Galilean optical design produces flat, crisp images to meet the demands of scientific research.

Adjustable arm stand

50mm coarse focus distance. The focus mechanism can also be lifted to accommodate large sample.

Forearm support

Compact, low-profile pad to support forearms. Reduces arm and shoulder fatigue from long-time operation.

Adjustable Mirror

The B2 base features a reflected mirror in the base which can be rotated 360 degrees to adjust contrast. Mirror has both a plain side and frosted side for different illumination effects.



Adjustable light intensity

Illumination intensity is displayed on the LCD screen on the BL10 base. This allows for repeatable illumination intensity for specific experiments or samples



LCD displays intensity and color temperature



Rotate for intensity adjustment

Customizable color temperature

Adjust the color temperature to create the ideal illumination setting for various samples and work environments.



Color temperature adjustment



5600K for natural light (white)



3200K for warm light (yellow)

Modular Design

Easily configure the LMS-Z400 series for life science and industrial applications.



Life Science

Ideal for life science research; meets the demands of biological experiments, chemical analysis and cell culture.

Industrial

Indispensable testing tool for surface detection of PCB, SMT, semiconductor chip, metal materials and precision components.

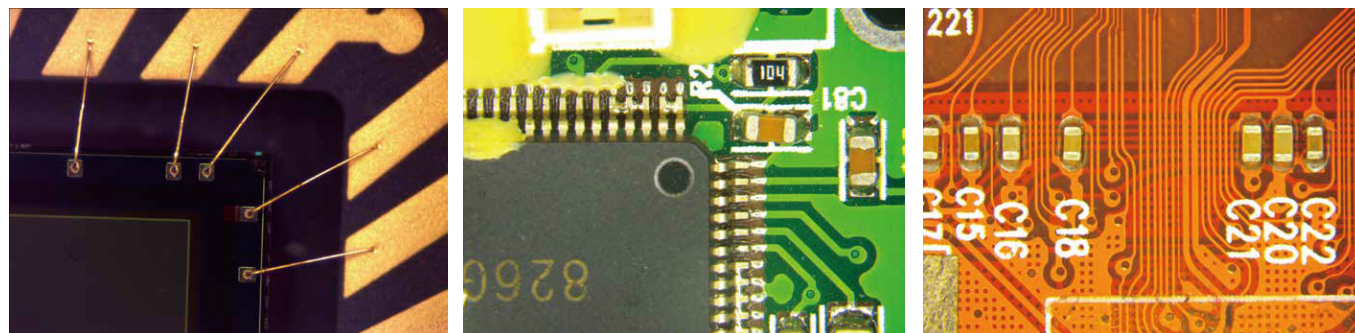

PL10X23mm eyepiece



1X & 2X APO main objectives



LED external illuminator



Single fiber optic light guide



LED dual gooseneck Illuminator



0.35X, 0.5X, 0.65X, 1X C-mounts





LED ring lamp (200 LEDs)

Optical Specifications

Eyepiece	1x Objective		2x Objective	
	Mag	FOV (mm)	Mag	FOV (mm)
10X/23mm	8X	28.75	16X	14.38
	100X	2.30	200X	1.15
15X/16mm	12X	20.00	24X	10.00
	150X	1.60	300X	0.80
20X/12.5mm	16X	15.63	32X	7.82
	200X	1.25	400X	0.63

Specifications

Viewing Head	Tilting trinocular viewing head, 5°-45° adjustable, fixed eyepiece tube, interpupillary range: 50mm - 76mm, light split: 100:0 or 0:100
	30° inclined trinocular head with fixed eyepiece tube, interpupillary range: 50mm - 76mm, light split: 50:50
Eyepiece	High eye-point wide field plan eyepiece PL10X/23mm, with adjustable diopter
	High eye-point wide field plan eyepiece PL15X/16mm, with adjustable diopter
	High eye-point wide field plan eyepiece PL20X/12.5mm, with adjustable diopter
Zoom Body	Zoom range: 0.8X~10X, zoom ratio: 12.5 : 1; built-in aperture diaphragm; click stop for 0.8X, 1X, 1.5X, 2X, 3X, 4X, 5X, 6X, 8X, 10X
Nosepiece	Single objective nosepiece
	Dual objective revolving nosepiece
Main Objective	1X APO objective, working distance 78mm
	2X APO objective, working distance 20mm
Focus Body	Coarse and fine coaxial focus system, integrated body with focus holder, coarse range: 50mm, fine precision 0.002mm
Base	B1: Plain base without illumination, black & white plate (dia.100mm)
	B2: Plain base with transmitted illumination (works with external 5W LED fiber); built-in 360 degree rotating mirror, adjustable
	BL10: Ultra-thin base, multi-LED (5W), with digital readout of light intensity and color temperature (3200~5600K)
Illumination	5W LED external illuminator (size: 270X100X130mm) with single fiber (500mm), color temperature 5000-5500K; operating voltage 100-240VAC/50-60Hz, output 12V
	LED ring lamp (200 LEDs)
Camera adapter	0.35X/0.5X/0.65X/1X C-mount adapter

LMS-Z400 SERIES		Standard Configurations	
			
SPECIFICATION		MODEL	
Part	Description	LMS-Z400TTR-B2	LMS-Z400TTR-BL10
EYEPIECE	High eye-point wide field plan eyepiece PL10X/23mm, with adjustable diopter	•	•
OBJECTIVE	1X APO objective, working distance 78mm	•	•
	2X APO objective, working distance 20mm		•
NOSEPIECE	Single objective nosepiece	•	
	Dual objective revolving nosepiece		•
HEAD TYPE	Tilting trinocular viewing head, 5°-45° adjustable, fixed eyepiece tube, interpupillary range: 50mm - 76mm, light split: 100:0 or 0:100	•	•
	30° inclined trinocular head with fixed eyepiece tube, interpupillary range: 50mm - 76mm, light split: 50:50		
STAND	B1: Plain base without illumination, black & white plate (dia.100mm)		
	B2: Plain base with transmitted illumination (works with external 5W LED fiber); built-in 360 degree rotating mirror, adjustable	•	
	BL10: Ultra-thin base, multi-LED (5W), with digital readout of light intensity and color temperature (3200~5600K)		•
ILLUMINATION	5W LED external illuminator (size: 270X100X130mm) with single fiber (500mm), color temperature 5000-5500K; operating voltage 100-240VAC/50-60Hz, output 12V	•	

ACCESSORIES

EYEPIECES

Part #	Description
LMCP-PLN10X22T	WF HP PL 10x Eyepiece, Diopter Adjustment, 22mm FOV
LMSP-PL15X16T	WF HP PL 15x Eyepiece, Diopter Adjustment, 16mm FOV
LMSP-PL20X12.5T	WF HP PL 20x Eyepiece, Diopter Adjustment, 12.5mm FOV

OBJECTIVE LENSES

Part #	Description
LMSP-Z400A01	1X APO objective, working distance 78mm
LMSP-Z400A02	2X APO objective, working distance 20mm

Dual Objective Nosepiece

Part #	Description
LMSP-Z400RE	Dual objective revolving nosepiece

LED Dual Gooseneck Illuminator

Part #	Description
AMPS-ILED-30W	LED Dual Gooseneck Illuminator with weighted base, white LED
LMSP-365	LED Module, 3W, 365nm, UV
LMSP-460	LED Module, 3W, 460nm, Blue
LMSP-520	LED Module, 1W, 520nm, Green
LMSP-630	LED Module, 3W, 630nm, Red
LMSP-730	LED Module, 1W, 730nm, IR

C-MOUNT CAMERA ADAPTERS

Part #	Description
LMCP-RX50MCTV0.5	0.5X camera tube, C-mount interface, adjustable
LMCP-RX50CTV0.65	0.65X camera tube, C-mount interface, adjustable focus
LMCP-RX50CTV1	1X camera tube, C-mount interface, adjustable

CAMERAS

Part #	Description
SeBaCam5C	5MP Digital Color Camera, CMOS, w/ SeBaView Imaging Software
SeBaCam10C	10MP Digital Color Camera, CMOS, w/ SeBaView Imaging Software
SeBaCam14C	14MP Digital Color Camera, CMOS, w/ SeBaView Imaging Software
SeBaCamCool1.4C	1.4MP Digital Camera, CCD, w/ SeBaView Imaging Software. Available in Color and Monochrome
SeBaCamCool1.4M	

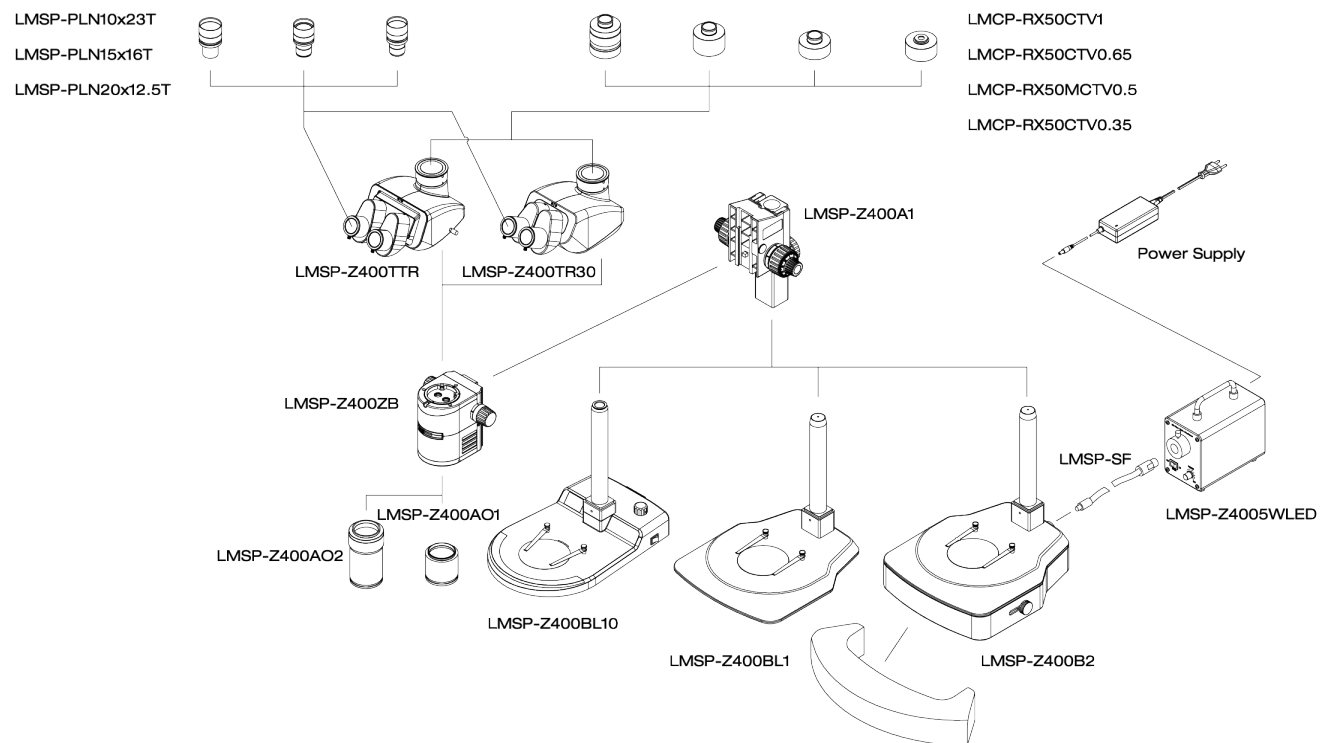

DIMENSIONS

B2 STAND

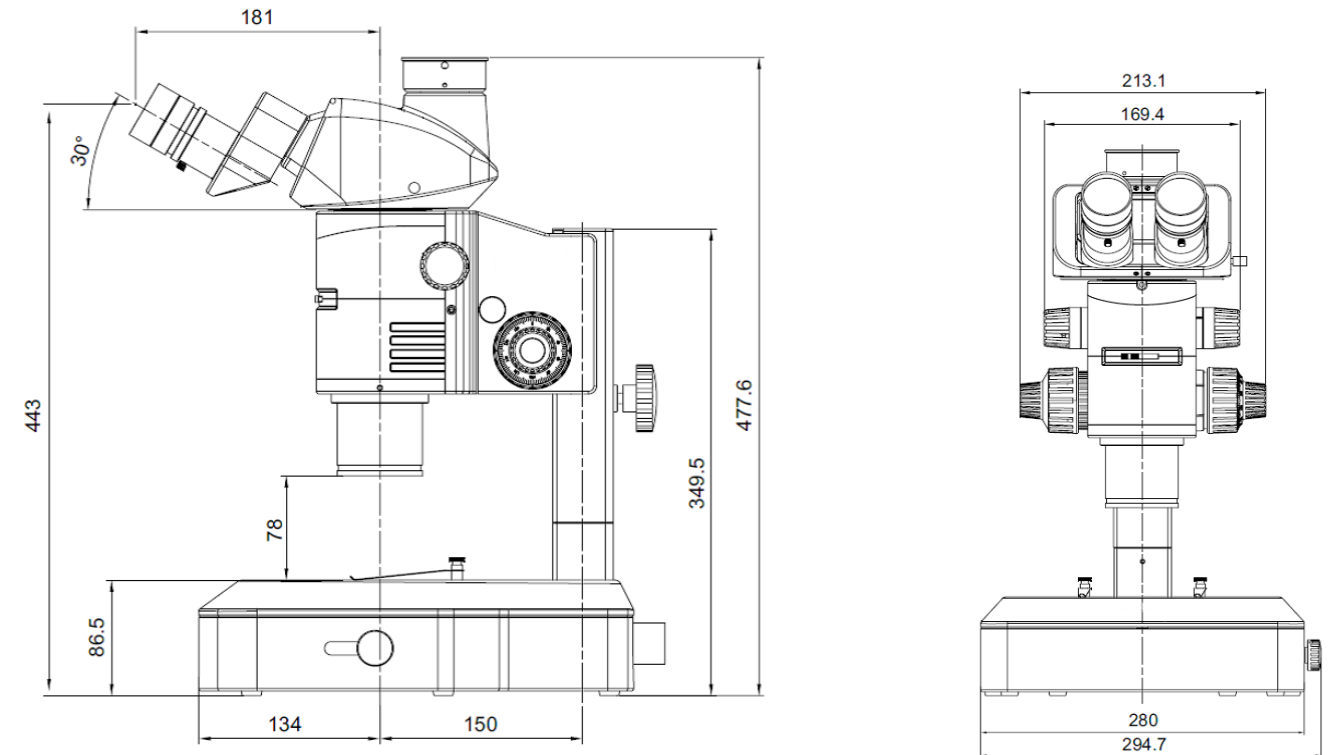

BL10 STAND

